



PB13H01.0

Product Specification

Approval Sheet

PB13H01.0 Product Specification

RoHS

Product	COB
Model Name	PB13H01.0
Issue Date	2016/03



■ Features

- ✓ White COB LED (13.5*13.5*1.5mm)
- ✓ Hot color targeting to 3 step ANSI eclipse bin
- ✓ 2700K, 3000K, 3500K, 4000K, 5000K, 6500K CCT available
- ✓ Dice Technology : InGaN
- ✓ Environmental friendly ; RoHS compliance

■ Applications

- ✓ Replacement lamp
- ✓ General lighting
- ✓ Indoor and outdoor commercial lighting
- ✓ PAR lamp, Downlight, Track light, Flood light etc.

Outline Dimension

PB13H01.0 Product Specification

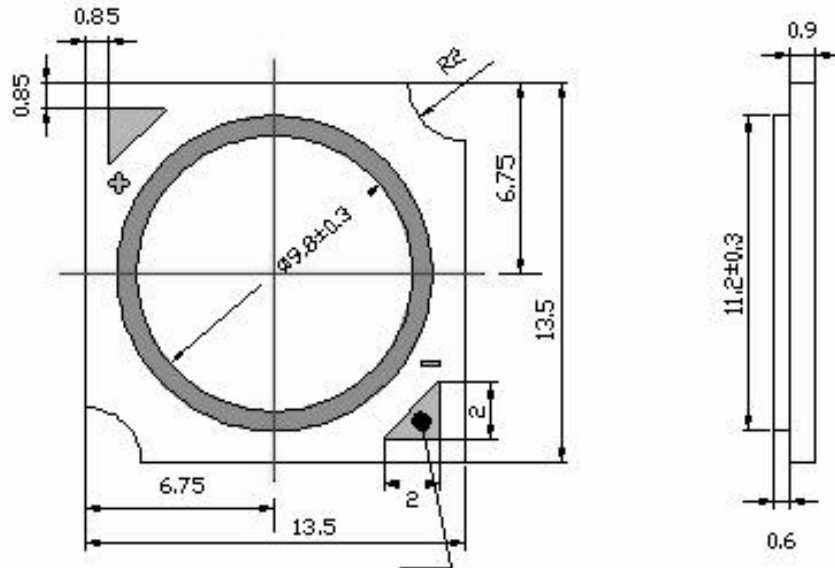

Tc Measurement Point

Unit: mm

Tolerances unless otherwise specified: ± 0.3 mm

The center of emitting surface to be centered ± 0.3 mm

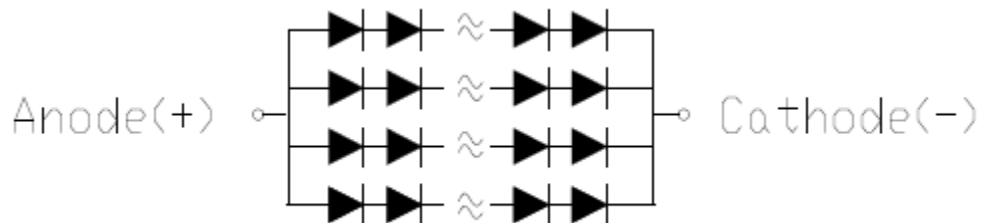

Note: Circuit layout is 6 series and 4 parallel

Performance

PB13H01.0 Product Specification

■ Electro-Optical Characteristics ($I_F=360\text{mA}$)

CCT	Luminous flux (lm)		CRI		Voltage (V)			Thermal Resistance ($^{\circ}\text{C}/\text{W}$)	View Angle (deg)
	$T_j=85$	$T_c=25^{(1)}$	Ra	R9	Min.	Typ.	Max.		
	Typ.	Typ.	Min.	Min.					
2700K	1,602	1,770	80	0	30.7	33.4	36.1	0.89	120
3000K	1,679	1,855							
3500K	1,718	1,899							
4000K	1,753	1,937							
5000K	1,769	1,955							
6500K	1,753	1,937							

Lextar Electronics maintains a tolerance of $\pm 3\%$ on forward voltage, $\pm 7\%$ on luminous flux, ± 2 on CRI and ± 6 on R9.

(1) Values of Luminous flux at $T_c=25^{\circ}\text{C}$ are provided as reference only.

■ Absolute Maximum Ratings

Parameter	Symbol	Value	Unit
DC Forward Current ⁽¹⁾	I_F	900	mA
Power Dissipation	P_d	33.0	W
Storage Temperature	T_c	-40 ~ 100	$^{\circ}\text{C}$
Junction Temperature	T_j	130	$^{\circ}\text{C}$
Substrate Temperature	T_{sub}	100	$^{\circ}\text{C}$
Manual Soldering Time at 300°C (Max)	T_{sol}	3.5	sec

(1) Please refer to the operating limit sections.

Ordering Code

PB13H01.0 Product Specification

P B 1 3 H 0 1 0 - A 3 0 0 3 0 R 2 R 4 D B - 0 0 0

1	2	3	4	5	6	7	8	9	10	11	12	13	14	15	16	17	18	19	20	21	22	23
---	---	---	---	---	---	---	---	---	----	----	----	----	----	----	----	----	----	----	----	----	----	----

Item	Pos.	Code	Spec
Model Name	1~8	PB09H01	PB09H01 V0
CIE Center Point	9	A	ANSI 1931 on B.B.L
Color Temperature ⁽¹⁾	10~11	30	3000K
CRI	12	0	No special requirements.
CIE Bin Group	13~14	30	3 SDCM
IV Bin Group	15~18	R2R4	Bin code : R2,R3,R4
		R3R5	Bin code : R3,R4,R5
Vf Bin Group	19~20	DB	Bin code : DB

(1) The two digits 30 means CCT in 3000K, can be replaced to 27 (2700K), 35(3500K), 40(4000K), 50(5000K), 65(6500K) for regarding CCT requirements.

Standard Ordering Code:

CCT	Ordering Code ⁽¹⁾	CIE Bin	CRI Bin	IV Bin	Vf Bin
2700K	PB13H010-A27030R1R3DB-000	273	A	R1,R2,R3	DB
3000K	PB13H010-A30030R2R4DB-000	303	A	R2,R3,R4	DB
3500K	PB13H010-A35030R2R4DB-000	353	A	R2,R3,R4	DB
4000K	PB13H010-A40030R3R5DB-000	403	A	R3,R4,R5	DB
5000K	PB13H010-A50030R3R5DB-000	503	A	R3,R4,R5	DB
6500K	PB13H010-A65030R3R5DB-000	653	A	R3,R4,R5	DB

(1) Only under an agreement between customer and Lextar Electronics, Ordering codes not in "Standard Ordering Code Definitions" can be supplied.

Binning

PB13H01.0 Product Specification

Chromaticity Coordinates (Extrapolated to $T_c=85^\circ\text{C}$)

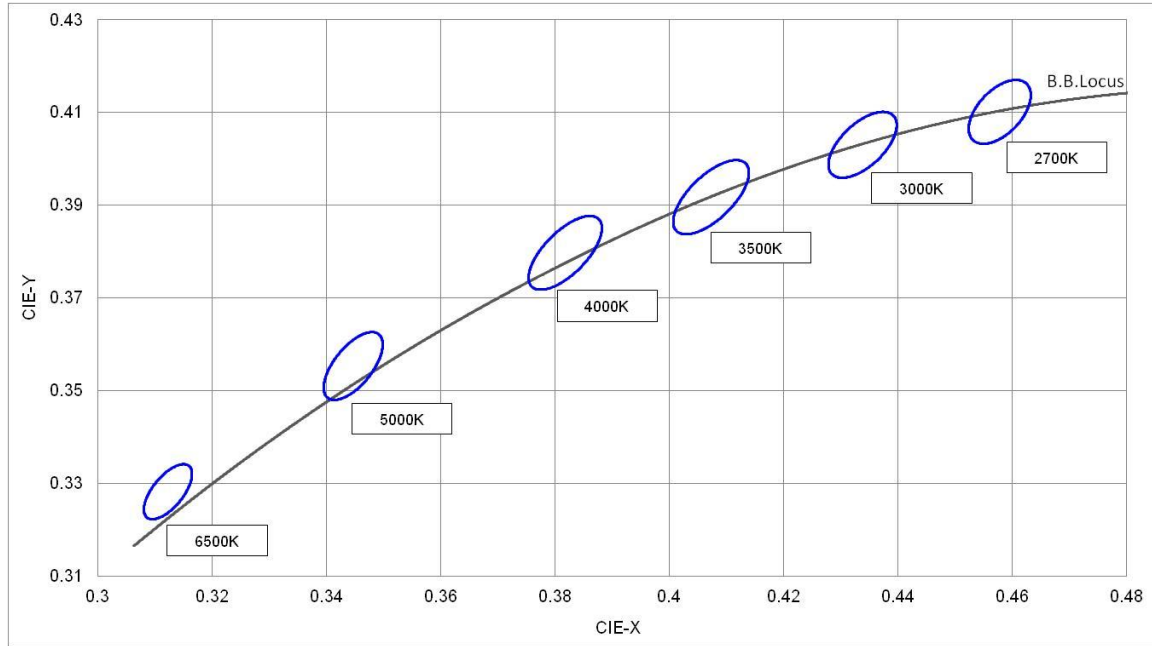

3-Step	2700K (273)	3000K (303)	3500K (353)	4000K (403)	5000K (503)	6500K (653)
Center Point, Cx	0.4578	0.4338	0.4073	0.3818	0.3447	0.3123
Center Point, Cy	0.4101	0.4030	0.3917	0.3797	0.3553	0.3282
Major Axis, a	0.00774	0.00834	0.00951	0.00939	0.00822	0.00669
Minor Axis, b	0.00411	0.00408	0.00417	0.00402	0.00354	0.00285
Rotation Angle	57.28	53.17	52.97	54.00	59.62	58.57

Tolerance of measurement is Chromaticity (x,y) \pm 0.005.

■ **Bin Code Definition**

CCT	Step	CRI	Flux	Voltage
27	3	A	U1	DB

CCT Bin Code	CCT
273	2700K-3step
303	3000K-3step
353	3500K-3step
403	4000K-3step
503	5000K-3step
653	6500K-3step

CRI Bin Code	CRI	R9
A	> 80	> 0

Flux Bin Code	T _c =85°C	
	Min	Max
R1	1440	1526
R2	1526	1612
R3	1612	1698
R4	1698	1784
R5	1784	1870

Voltage Bin Code	T _c =85 °C		T _c =25 °C	
	Min	Max	Min	Max
DB	30.7	36.1	32.0	37.6

Values of T_c=25°C are provided as reference only.

Characteristics

PB13H01.0 Product Specification

Spectrum

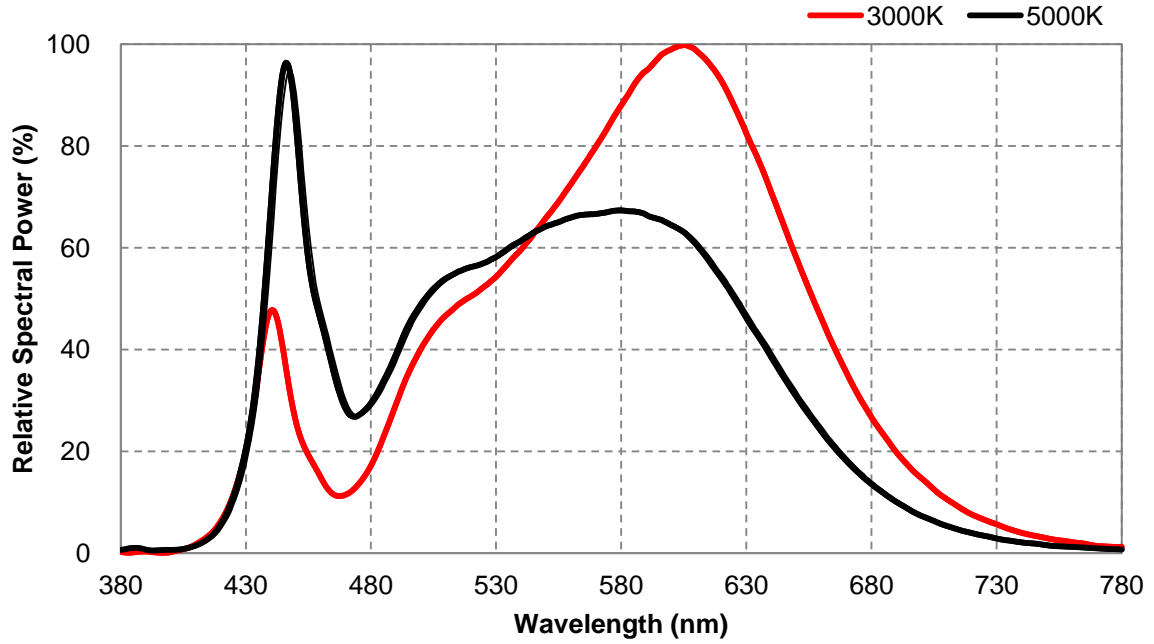

Radiation Pattern

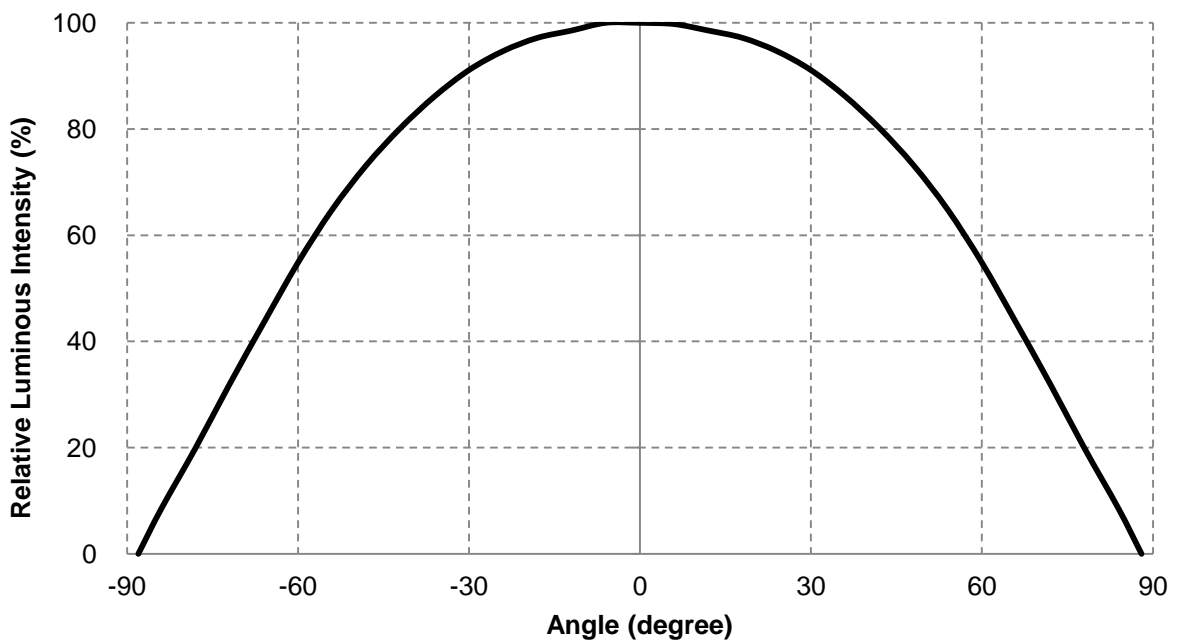

■ **Forward Voltage vs. Forward Current ($T_c=85^\circ\text{C}$)**

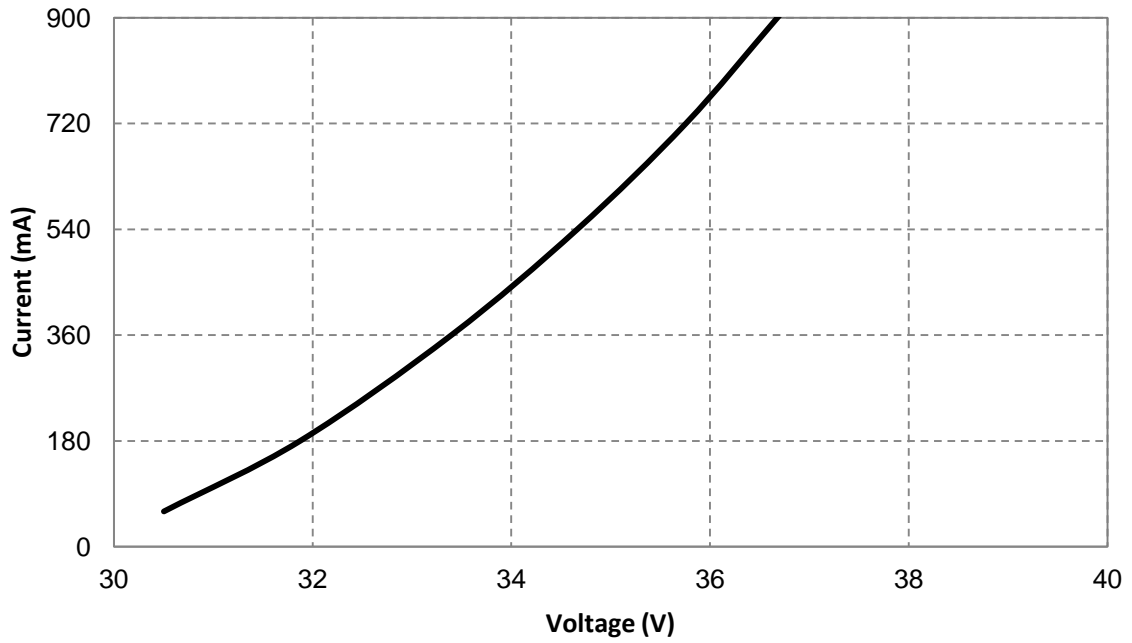

■ **Forward Current vs. Related Luminous Flux ($T_c=85^\circ\text{C}$)**

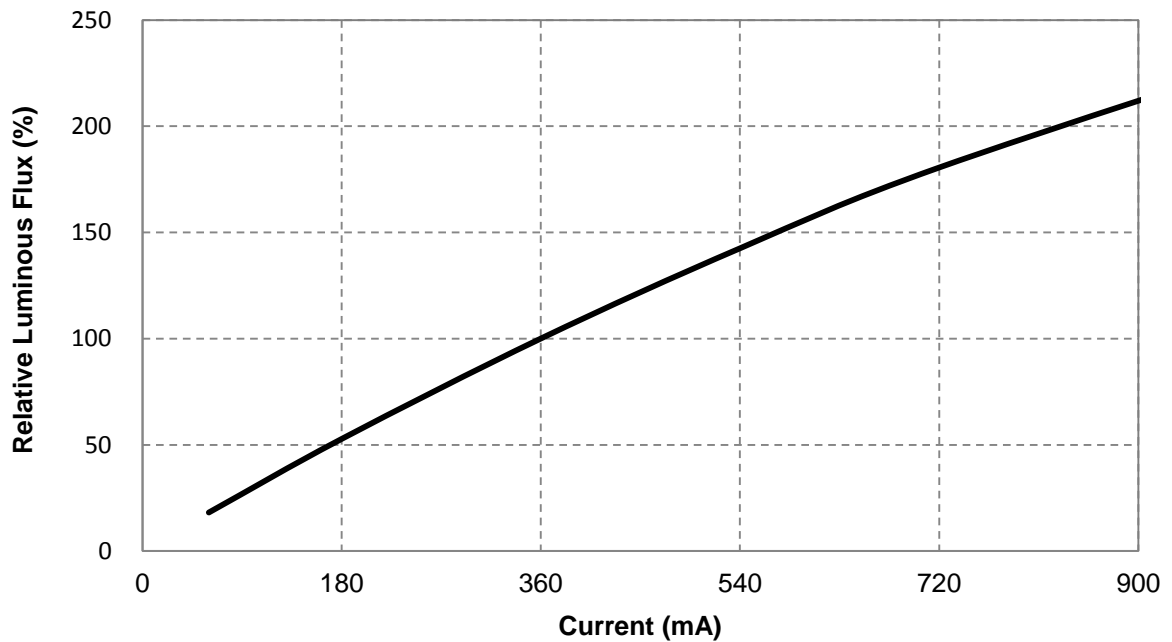

■ **Forward Current vs. Chromaticity Coordinate ($T_c=85^\circ\text{C}$)**

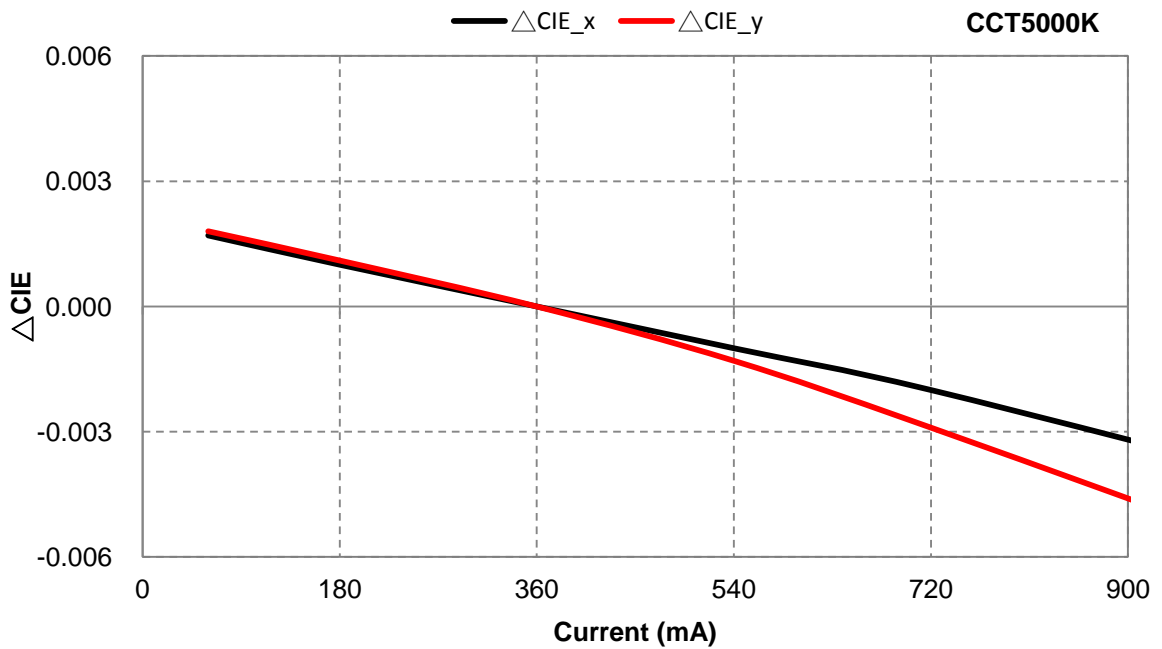
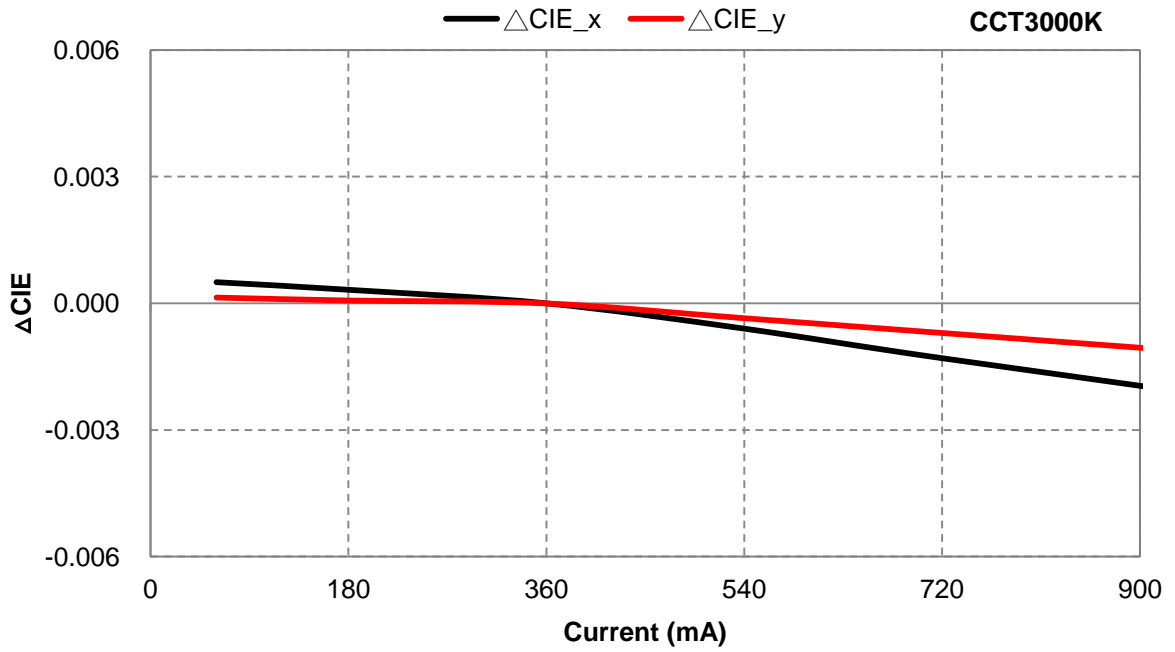

■ **Case Temperature vs. Forward Voltage ($I_F=360\text{mA}$)**

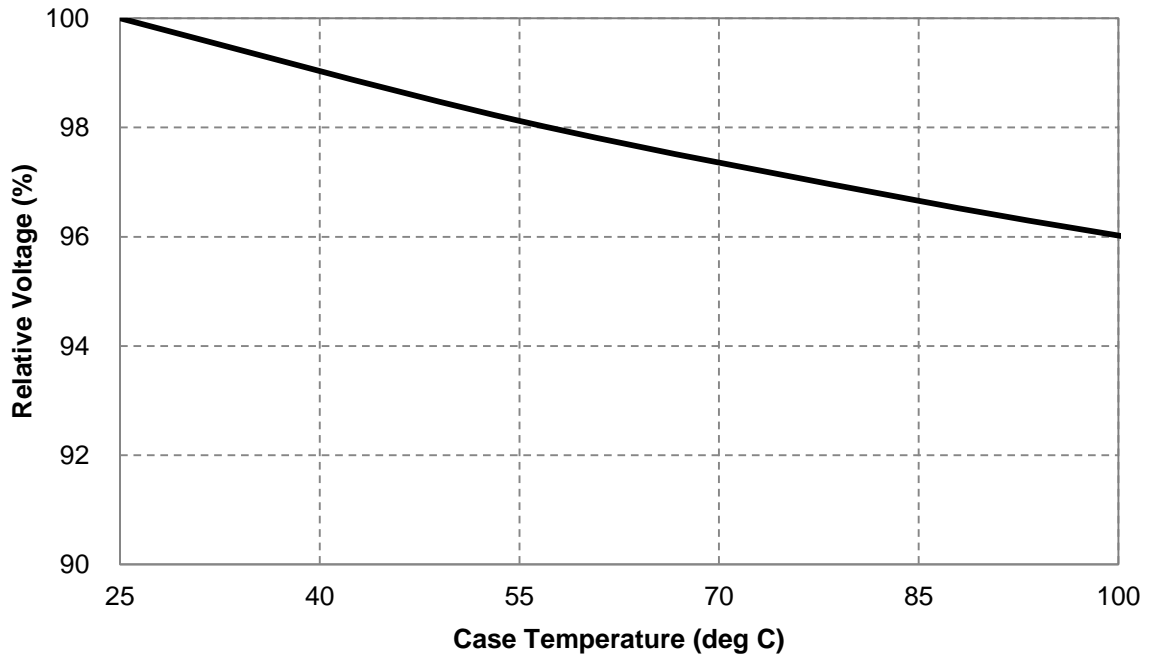

■ **Case Temperature vs. Relative Luminous Flux ($I_F=360\text{mA}$)**

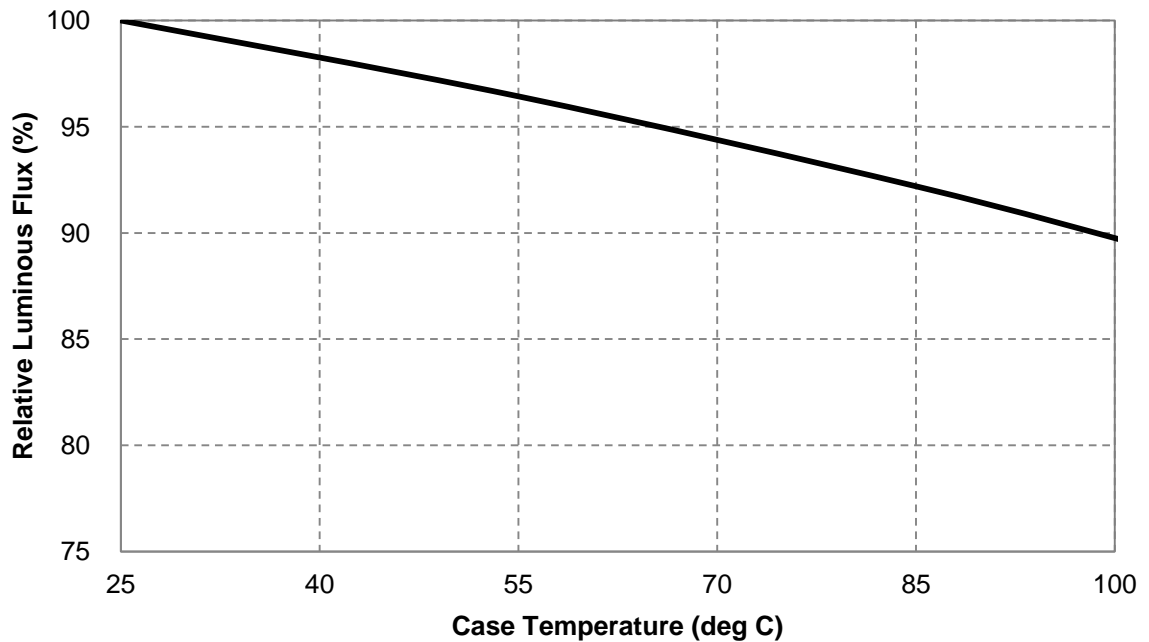

■ Case Temperature vs. Chromaticity Coordinate ($I_F=360mA$)

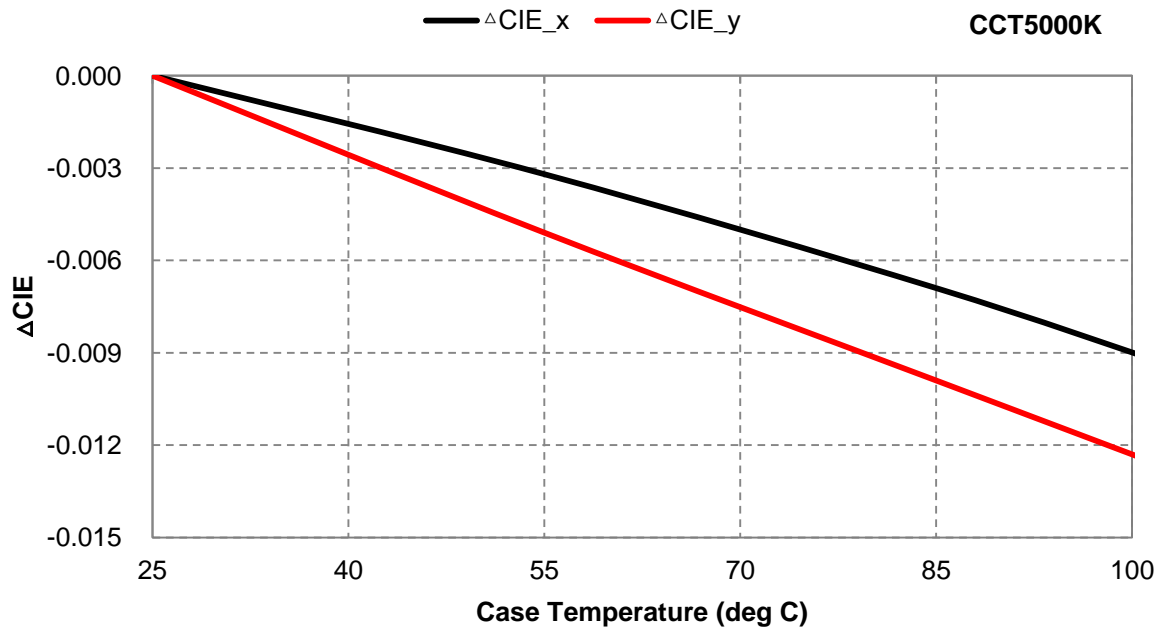
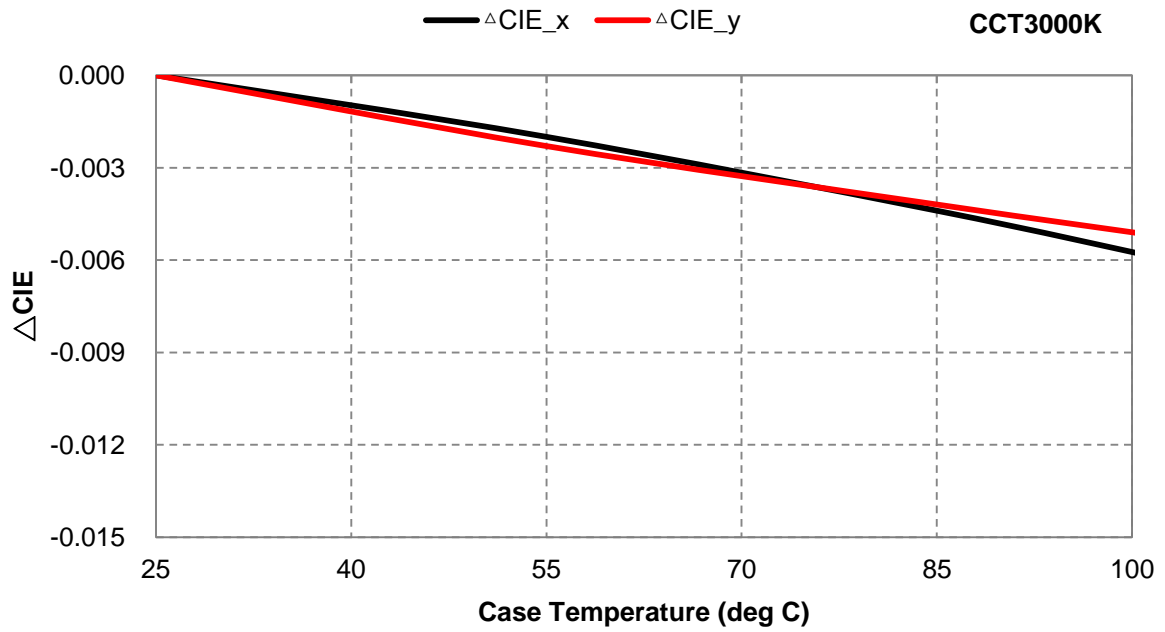

■ **Derating Characteristics**

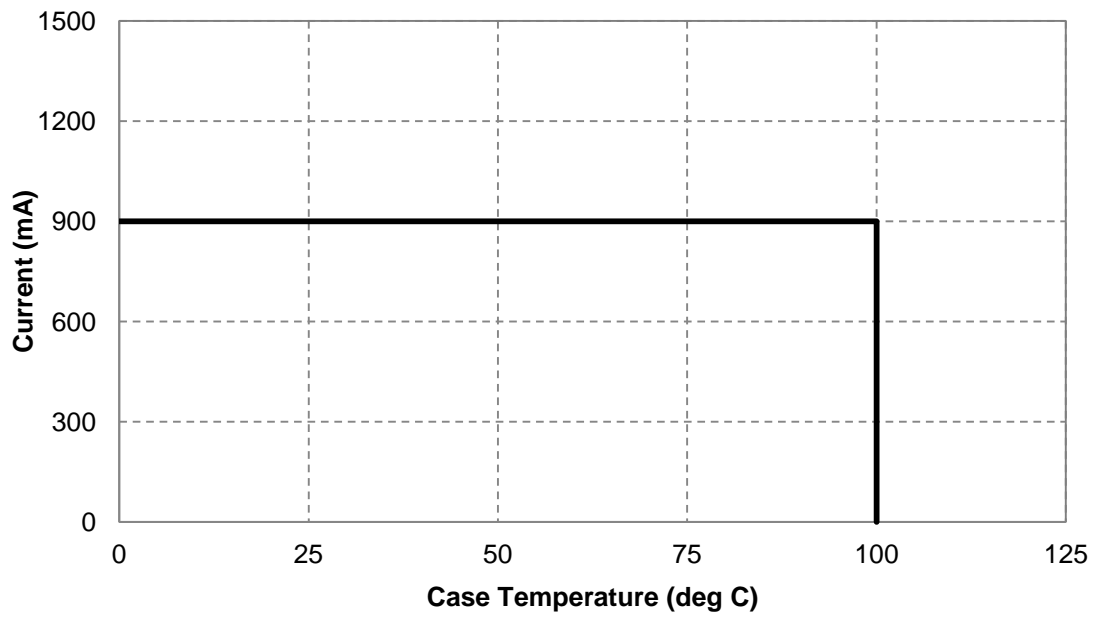

Reliability

PB13H01.0 Product Specification

Reliability Test

No	Item	Condition	Time/Cycle
1	High Temperature Operation Life Test	$T_c = 85^\circ\text{C}$	1000 Hrs
2	Low Temperature Operation Life Test	$T_a = -40^\circ\text{C}$	1000 Hrs
3	High Temperature and High Humidity Operation Life Test	$T_c = 85^\circ\text{C}, 85\%\text{RH}$	1000 Hrs
4	High Temperature Storage	$T_a = 100^\circ\text{C}$	1000 Hrs
5	Low Temperature Storage	$T_a = -40^\circ\text{C}$	1000 Hrs
6	High Temperature High Humidity Storage	$T_a = 85^\circ\text{C}, 85\% \text{ RH}$	1000 Hrs
7	Temperature Cycle Storage	$-40^\circ\text{C} \sim 100^\circ\text{C}$ (20min dwell) /5min transfer	300 Cycles

Judgment Criteria

Item	Symbol	Judgment Criteria
Forward Voltage	V_F	$\Delta V_F < 10\%$
Luminous Flux	I_v	Decay $\leq 20\%$

Packing

PB13H01.0 Product Specification

■ Dimensions

Item	Length (mm)	Width (mm)	Height (mm)	Max. quantity in pcs of COB	Weight (kg)
Outer Box	370	260	360	1944	5
Inner Box	350	250	55	324	0.75
Tray	307	207	12	54	0.07

■ Tray

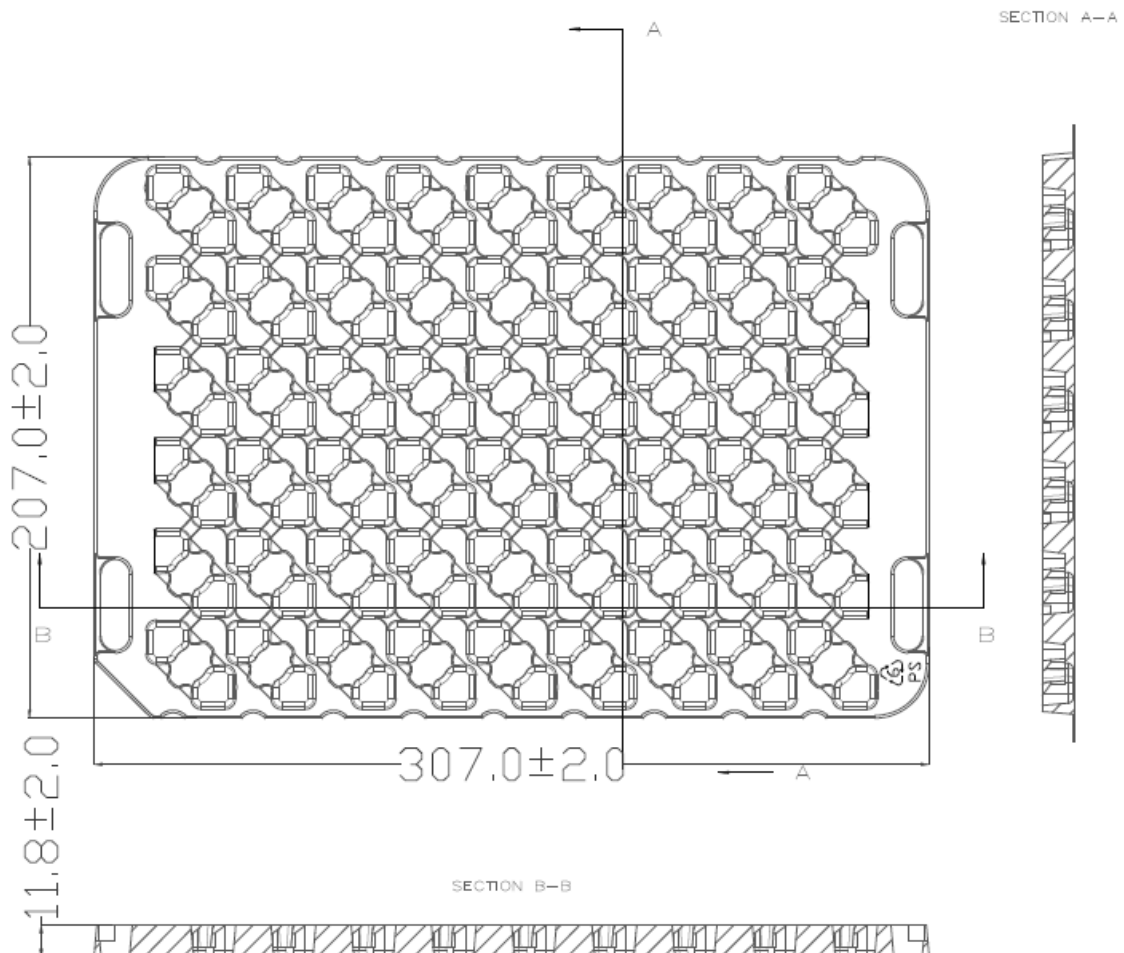

■ **Packing Structure**

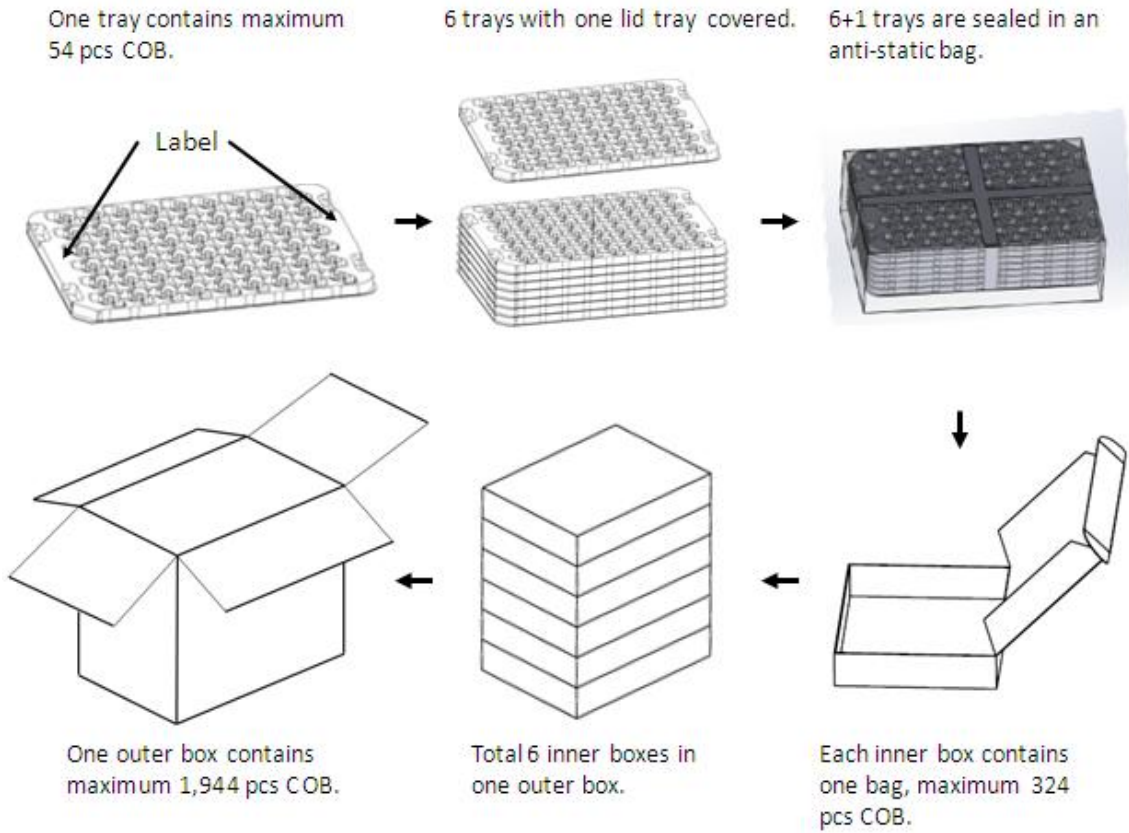

■ **Label Information**



WO : Working number
 EQP ID : Equipment ID
 P/N : Part number



SHIP ID : Shipment IS
 BIN CODE : BIN CODE
 M/N : Model Name
 QTY : Quantity

Precautions

PB13H01.0 Product Specification

1. Avoid the application of any stress to the resin portion (lighting area).
2. Avoid any contact by a sharp metal nail or other materials with the resin portion (lighting area).



3. This product should be secured firmly by fastening screws on both sides of the product. Please be careful not to apply any stress to the product during the clamping operation.



4. For fixing this product to the outer heat sink, thermal pad or thermal glue should be applied between backside of substrate and heat sink so that the product can dissipate heat completely. Please avoid product deformation when fixing the clamping operation.
5. Handling of static electricity
 - These products are sensitive to static electricity charge. Please prevent any static electricity within the assembling process.
 - All devices, equipment and machinery must be properly grounded. It is recommended that precautions be taken against surge voltage to the equipment that mounts the LEDs.
 - ESD sensitivity of this product is 1000V (HBM, based on JEITA ED-4701/304).
 - It is easy to find static-damaged LEDs by a light-on test.
6. Before open the package, should kept at room temperature, 90% RH environment or less. The LED should be used within 6 months.
7. After open the package, the LED should be kept at room temperature, 60% RH environment or less. The LED should be soldered within 168 hours (7 days) after opening the package. If unused LEDs remain, they should be stored in moisture proof packages, such as sealed containers with packages of moisture absorbent material (silica gel).
8. Applying proper resistor for the circuit design is recommended. Otherwise slight voltage shift may cause big current change and the LED may be burn out.
9. Please ensure that heat and electronic generation is not in excess of the absolute maximum rating.

Revision History

PB13H01.0 Product Specification

Date	Contents	Writer
2016.03.05	Datasheet Initial	Chin Lin
2016.03.31	Update flux bin definitions	Chin Lin
2016.06.30	Add ordering code	Chin Lin
2016.10.05	Packing modification	Chin Lin

Lextar Electronics Corp. reserves the right to modify the technical information or data without notification when product is improved.

Smart Lighting Amazing Life

Lextar Electronics Corp. is the leading LED (Light Emitting Diode) maker integrating upper stream epitaxial, middle stream chip, and downstream package, SMT and LED lighting applications. Founded in May, 2008, Lextar is a subsidiary of AU Optronics, the leading TFT-LCD and solar PV manufacturer. Lextar's product applications include lighting and LCD backlight. Lextar's manufacturing sites include Hsinchu and Chunan in Taiwan, and Suzhou in China.

The company turnover in 2010 is 266 million USD.